

HS

(Hindernisstrecke)

6900 Meter

Geländefahren Kl. S

Prfg.Nr:

19;23;27;31 und 35

Richtv:LPO§§752,753

Pflichttore 1 - 19

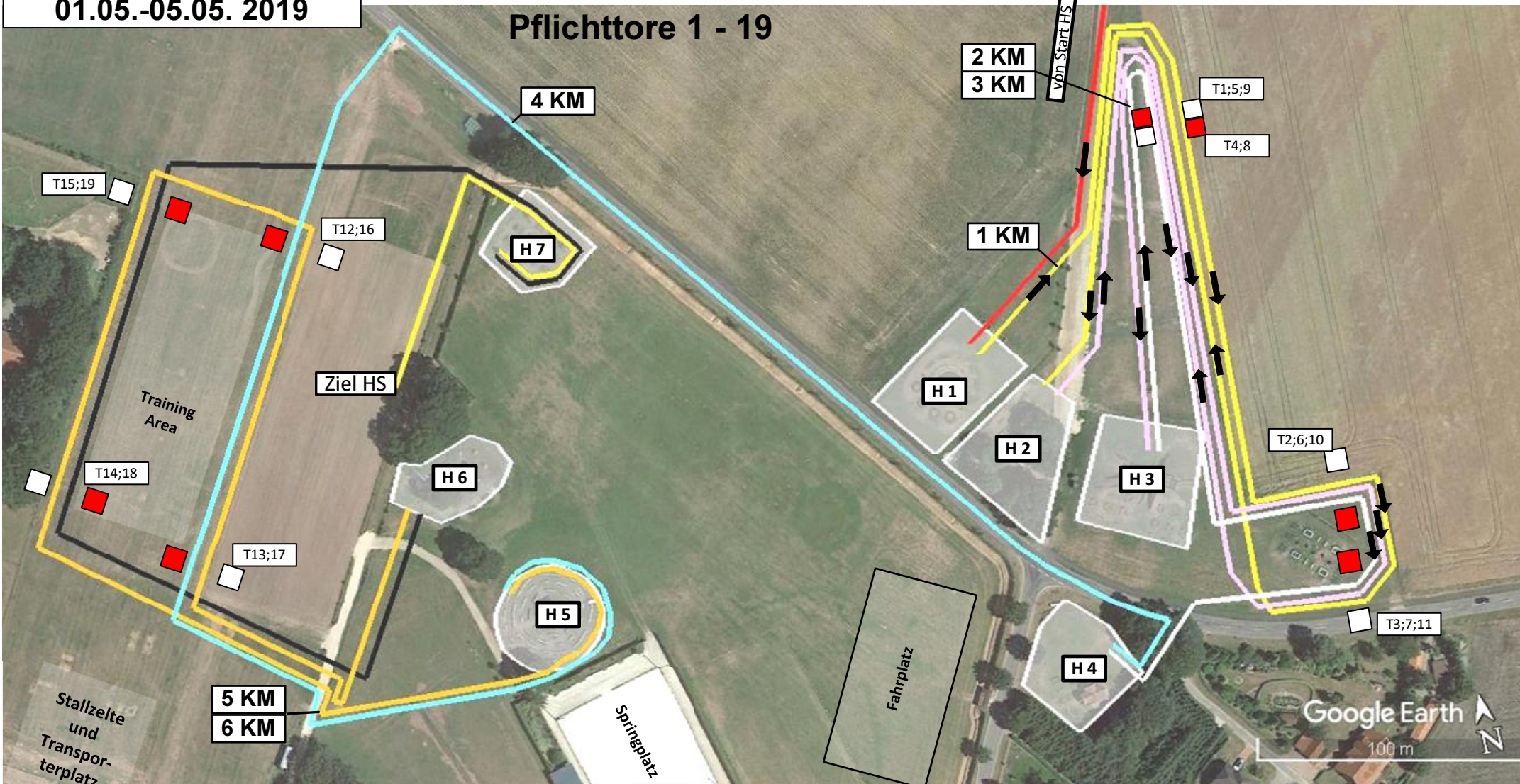

Reihenfolge: Start HS / H1 / 1KM / T1 / T2 / T3 / T4 / H2 / 2KM / T5 / T6 / T7 / T8 / H3 / 3KM / T9 / T10 / T11 / H4 / 4KM / T12 / T13 / H5 / 5KM / T14 / T15 / T16 / T17 / H6 / 6KM / T18 / T19 / H7 / 30m / Ziel HS.



Geländefahren Kl. S

Prfg.Nr: 19;23;27;31 und35

Richtv:LPO§§752,753

Times Marathon

Zeiten Marathon

Klasse S Pferde Prfg.: 19; 27 und 35		Länge in Meter	Tempo KM/h	Bestzeit h:min:sec	Erlaubte Zeit h:min:sec	Höchstzeit h:min:sec
AWS	Aufwärmstrecke	5900	12	00:27:30	00:29:30	00:35:24
HS	Hindernisstrecke	6900	14	00:26:34	00:29:34	00:59:09
Klasse S Ponys Prfg.: 23 und 31		Länge in Meter	Tempo KM/h	Bestzeit h:min:sec	Erlaubte Zeit h:min:sec	Höchstzeit h:min:sec
AWS	Aufwärmstrecke	5900	11	00:30:11	00:32:11	00:38:37
HS	Hindernisstrecke	6900	13	00:28:51	00:31:51	01:03:42

Powered by: **SENGER**
 Faszination Automobil

„Senger-Brunnen“

Geländefahren Kl. S



Prfg.Nr:

19;23;27;31 und 35

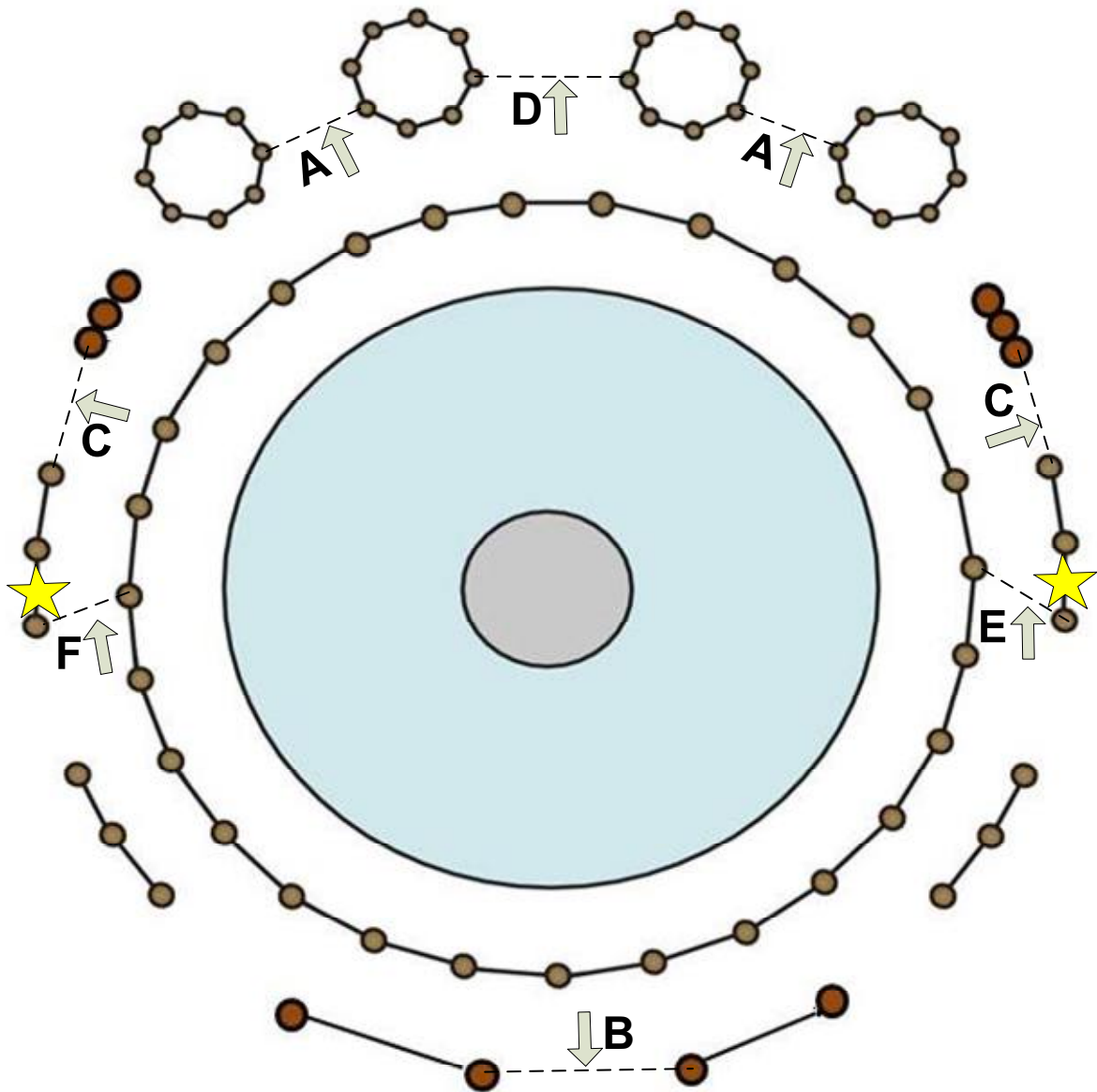
Richtv:LPO§§752,753



 = 2 abwerfbare Teile/
 Knock Down

 Start / Finish 

© Parcourschef Josef Heisterkamp
Just **U**nbelievable **P**arcours **P**roperties
Always **O**ne **O**bstacle **A**head
www.jupp-fahrsport.de

Powered by: **VGH** 

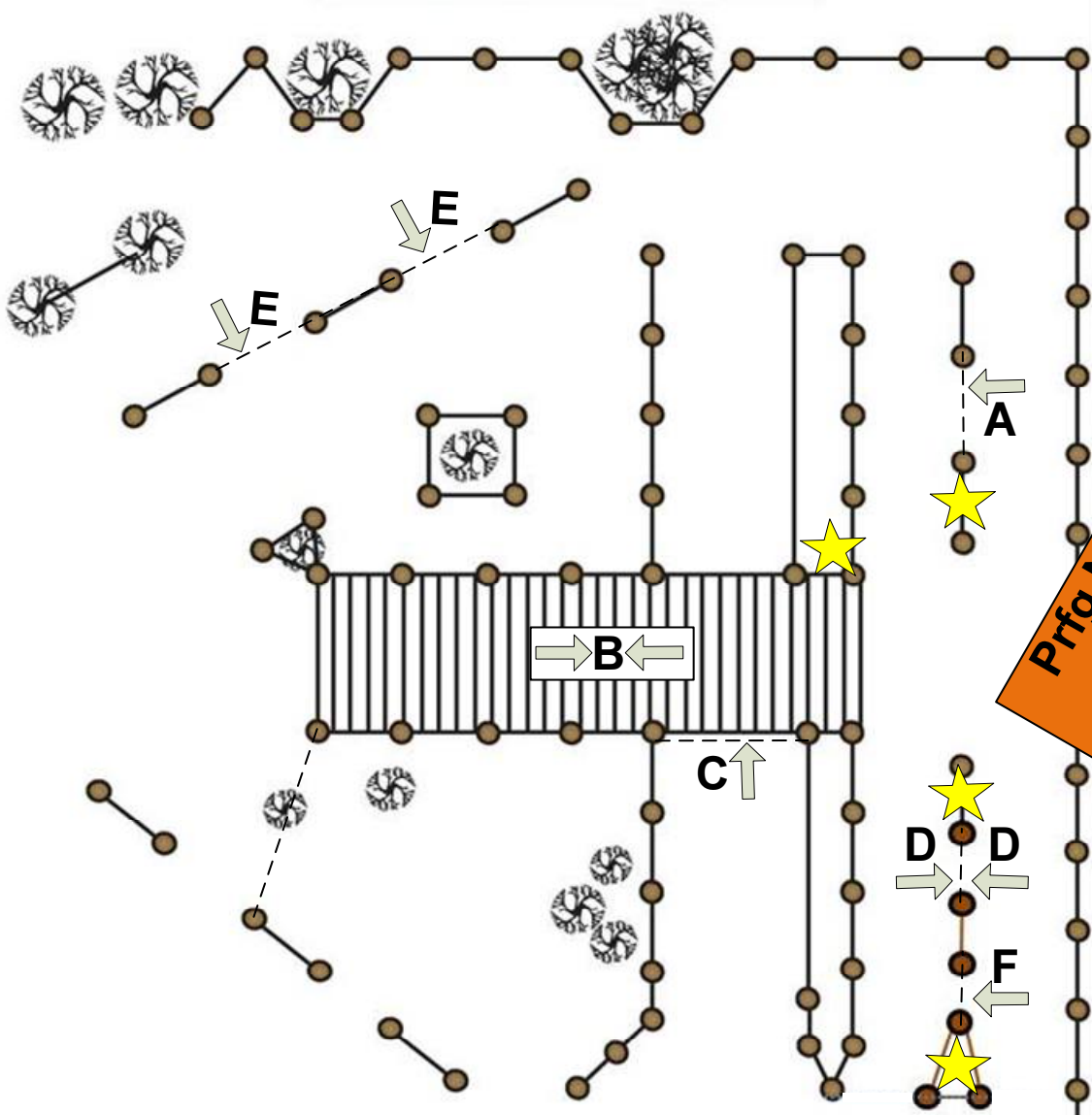

Geländefahren Kl. S
 Prfg.Nr:
 19;23;27;31und35
 Richtv:LPO§§752,753

„VGH-Brücke“



**Prfg.Nr 35 Einspänner
 Pferde nur A-E**

 = 4 abwerfbare Teile/
 Knock Down

 Start / Finish 

Powered by:



Hindernis
Obstacle

3



„SPARKASSEN

Tunnel“

Geländefahren Kl. S

Prfg.Nr:

19;23;27;31und35

Richtv:LPO§§752,753

Prfg.Nr 35 Einspänner
Pferde **nur A-E**

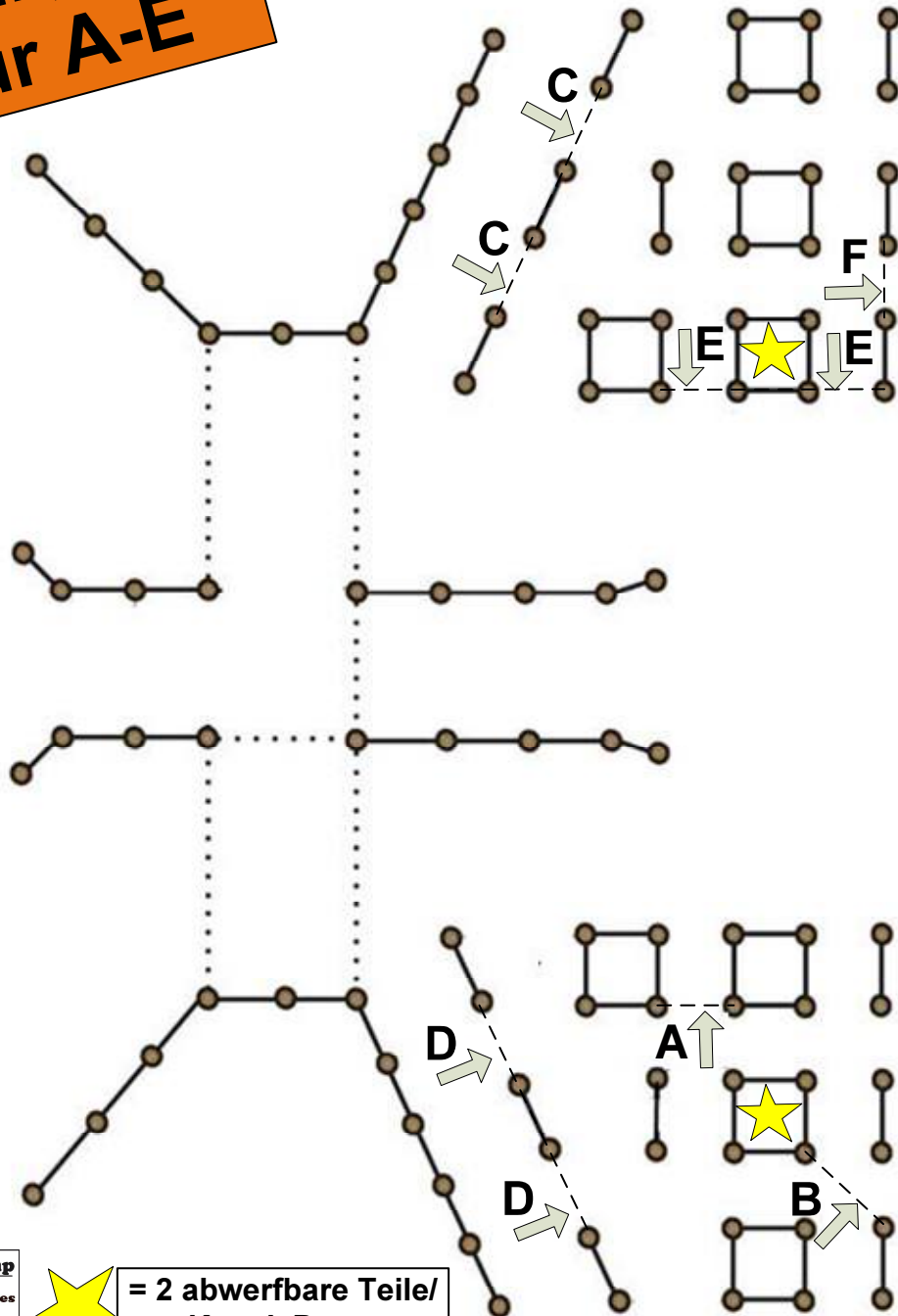
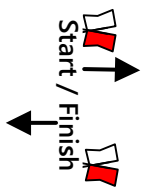

Powered by:



Geländefahren Kl. S
 Prfg.Nr:
 19;23;27;31und35
 Richtv:LPO§§752,753

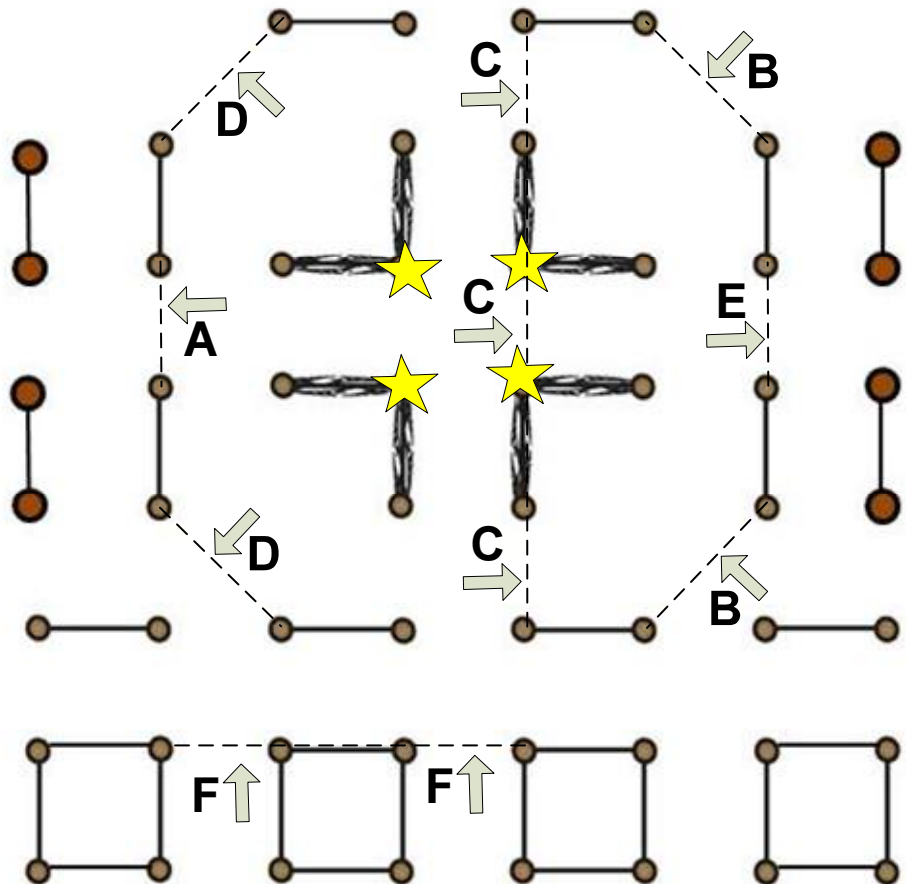

 = 4 abwerfbare Teile/
 Knock Down

Hindernis **5**
Obstacle

„GEWA - Turm“

Powered by:



Geländefahren Kl. S
Prfg.Nr:
19;23;27;31und35
 Richtv:LPO§§752,753

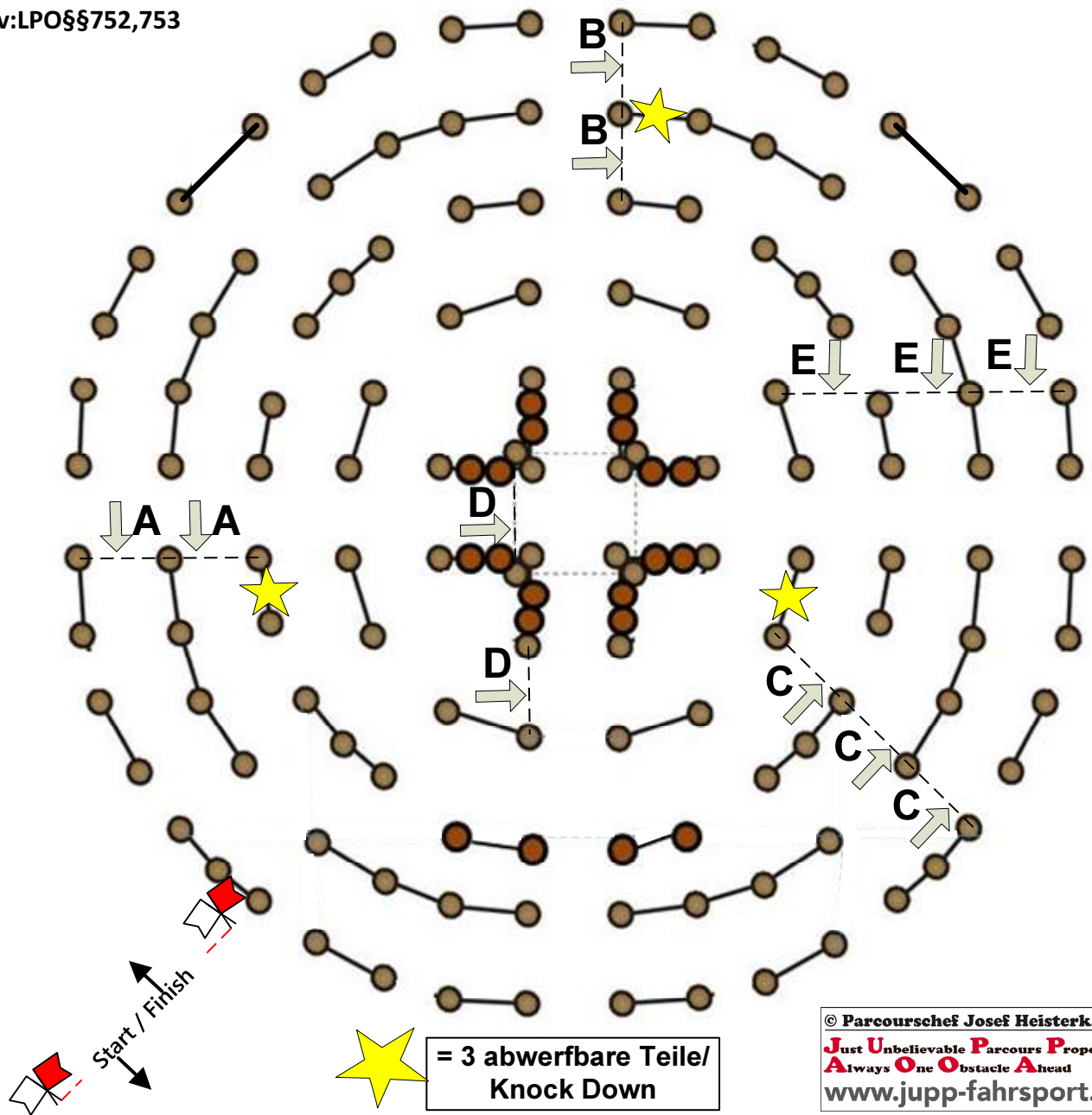

Hindernis 6

Obstacle „PRIL - Eichenwall“

Powered by:



Geländefahren Kl. S

Prfg.Nr:

19;23;27;31 und 35

Richtv: LPO §§ 752, 753

Prfg.Nr 35 Einspänner
 Pferde **nur A-E**

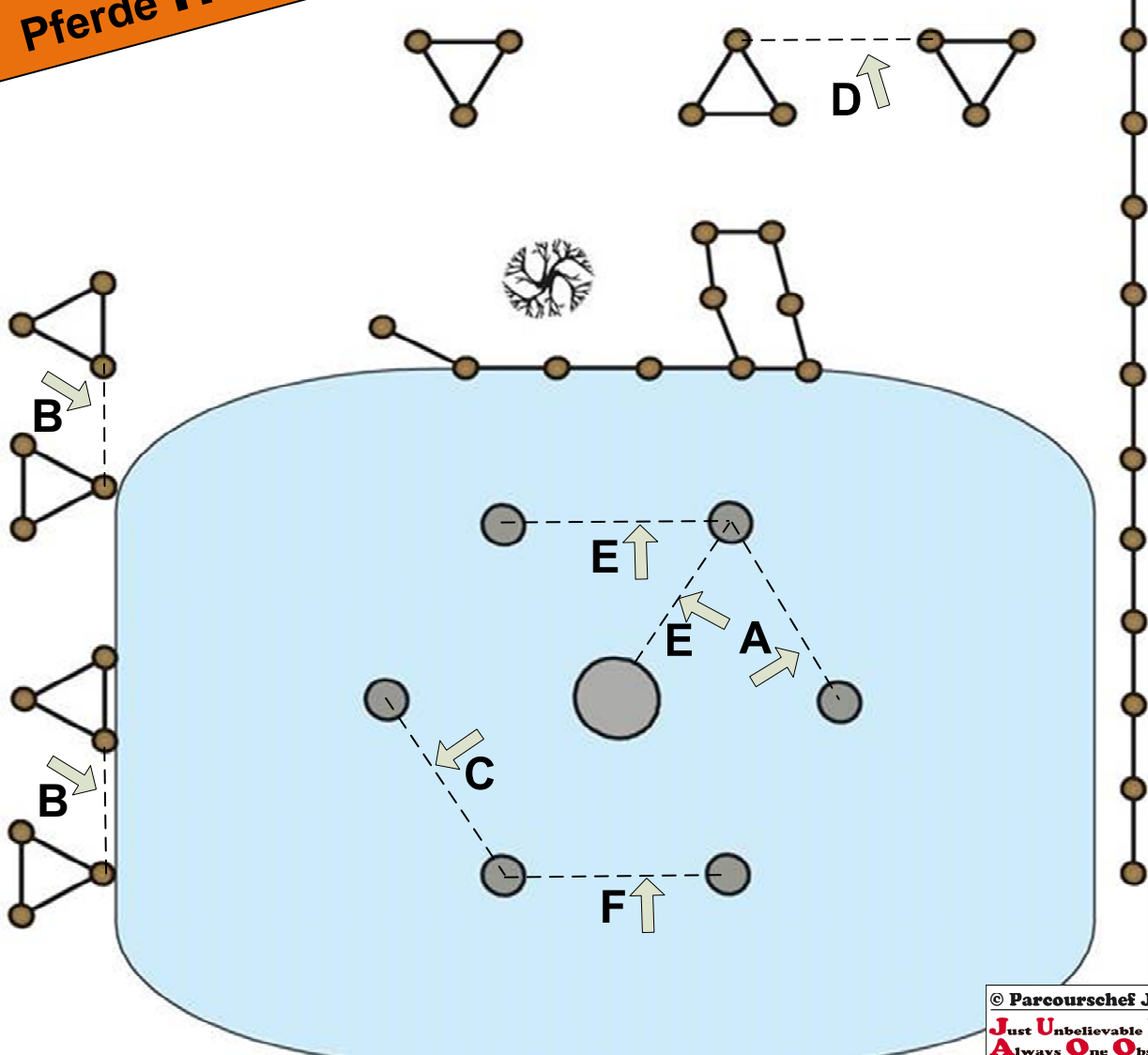
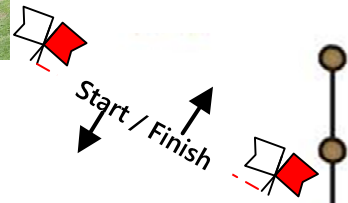

Hindernis 7

Obstacle „ASP - Pyramide“

Powered by:



Geländefahren Kl. S
 Prfg.Nr:
 19;23;27;31und35
 Richtv:LPO§§752,753

